

SKKT 132, SKKH 132



SEMIPACK[®] 2

Thyristor / Diode Modules

SKKT 132

SKKH 132

Features

- Heat transfer through aluminium oxide ceramic isolated metal baseplate
- Hard soldered joints for high reliability
- UL recognized, file no. E 63532

Typical Applications*

- DC motor control (e. g. for machine tools)
- Temperature control (e. g. for ovens, chemical processes)
- Professional light dimming (studios, theaters)

1) See the assembly instructions

V_{RSM} V	V_{RRM}, V_{DRM} V	$I_{TRMS} = 220$ A (maximum value for continuous operation) $I_{TAV} = 130$ A (sin. 180; $T_c = 87$ °C)	
900	800	SKKT 132/08E	SKKH 132/08E
1300	1200	SKKT 132/12E	SKKH 132/12E
1500	1400	SKKT 132/14E	SKKH 132/14E
1700	1600	SKKT 132/16E	SKKH 132/16E
1900	1800	SKKT 132/18E	SKKH 132/18E

Symbol	Conditions	Values	Units
I_{TAV}	sin. 180; $T_c = 85$ (100) °C;	137 (96)	A
I_D	P3/180; $T_a = 45$ °C; B2 / B6	77 / 100	A
	P3/180F; $T_a = 35$ °C; B2 / B6	170 / 200	A
I_{RMS}	P3/180F; $T_a = 35$ °C; W1 / W3	240 / 3 * 163	A
I_{TSM}	$T_{vj} = 25$ °C; 10 ms	4700	A
	$T_{vj} = 125$ °C; 10 ms	4000	A
i^2t	$T_{vj} = 25$ °C; 8,3 ... 10 ms	110000	A ² s
	$T_{vj} = 125$ °C; 8,3 ... 10 ms	80000	A ² s
V_T	$T_{vj} = 25$ °C; $I_T = 500$ A	max. 1,8	V
$V_{T(TO)}$	$T_{vj} = 125$ °C	max. 1	V
r_T	$T_{vj} = 125$ °C	max. 1,6	mΩ
$I_{DD}; I_{RD}$	$T_{vj} = 125$ °C; $V_{RD} = V_{RRM}; V_{DD} = V_{DRM}$	max. 40	mA
t_{gd}	$T_{vj} = 25$ °C; $I_G = 1$ A; $di_G/dt = 1$ A/μs	1	μs
t_{gr}	$V_D = 0,67 * V_{DRM}$	2	μs
$(di/dt)_{cr}$	$T_{vj} = 125$ °C	max. 200	A/μs
$(dv/dt)_{cr}$	$T_{vj} = 125$ °C	max. 1000	V/μs
t_q	$T_{vj} = 125$ °C	50 ... 150	μs
I_H	$T_{vj} = 25$ °C; typ. / max.	150 / 400	mA
I_L	$T_{vj} = 25$ °C; $R_G = 33$ Ω; typ. / max.	300 / 1000	mA
V_{GT}	$T_{vj} = 25$ °C; d.c.	min. 2	V
I_{GT}	$T_{vj} = 25$ °C; d.c.	min. 150	mA
V_{GD}	$T_{vj} = 125$ °C; d.c.	max. 0,25	V
I_{GD}	$T_{vj} = 125$ °C; d.c.	max. 10	mA
$R_{th(j-c)}$	cont.; per thyristor / per module	0,18 / 0,09	K/W
$R_{th(j-c)}$	sin. 180; per thyristor / per module	0,19 / 0,095	K/W
$R_{th(j-c)}$	rec. 120; per thyristor / per module	0,21 / 0,105	K/W
$R_{th(c-s)}$	per thyristor / per module	0,1 / 0,05	K/W
T_{vj}		- 40 ... + 125	°C
T_{stg}		- 40 ... + 125	°C
V_{isol}	a. c. 50 Hz; r.m.s.; 1 s / 1 min.	3600 / 3000	V~
M_s	to heatsink	5 ± 15 % ¹⁾	Nm
M_t	to terminal	5 ± 15 %	Nm
a		5 * 9,81	m/s ²
m	approx.	165	g
Case	SKKT	A 21	
	SKKH	A 22	



SKKT

SKKH

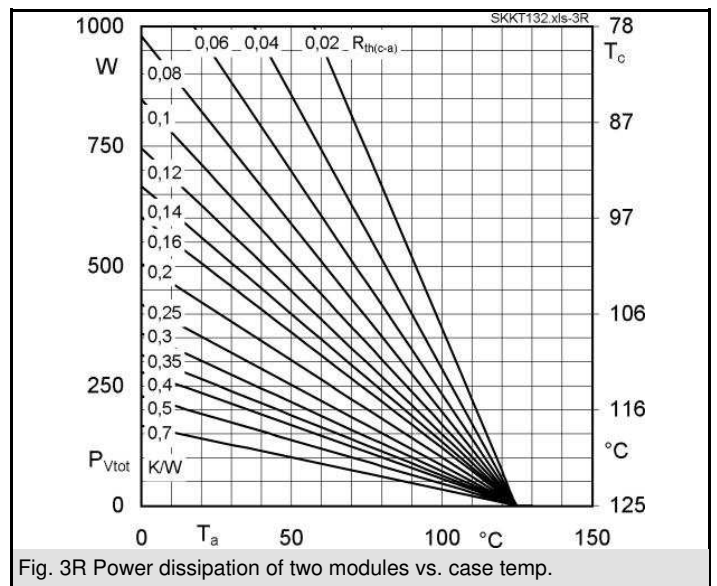
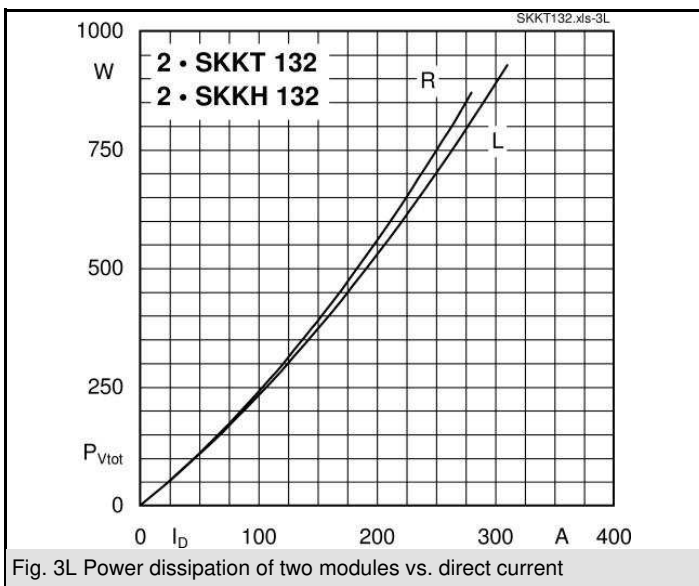
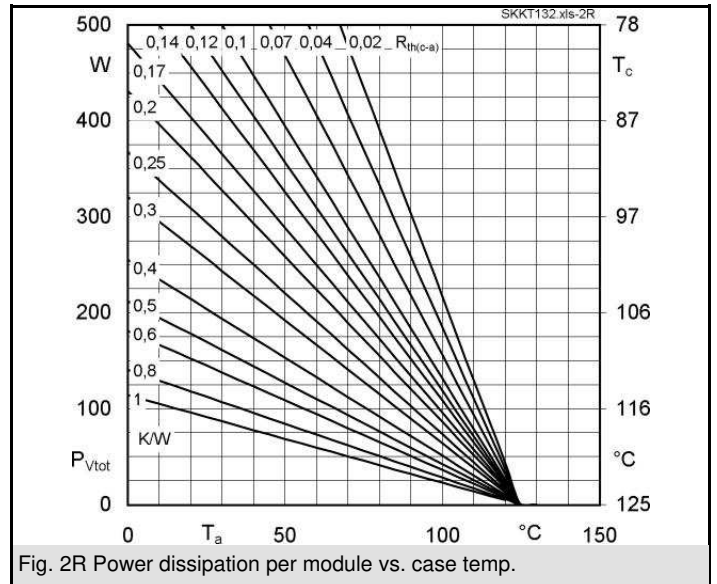
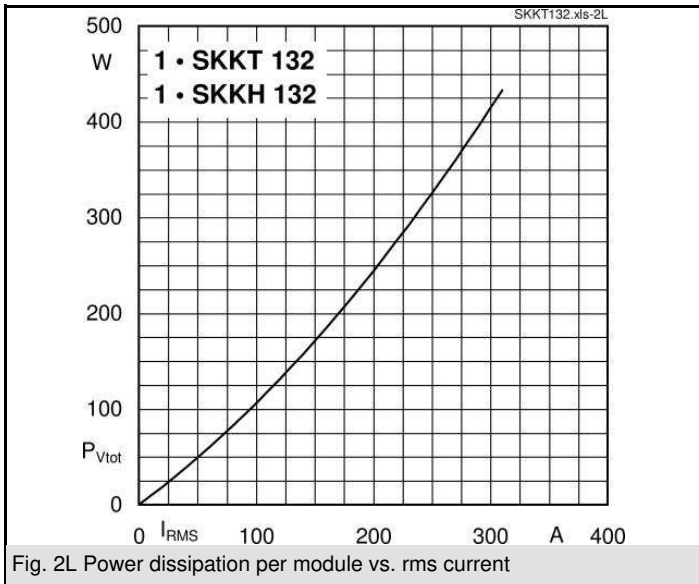
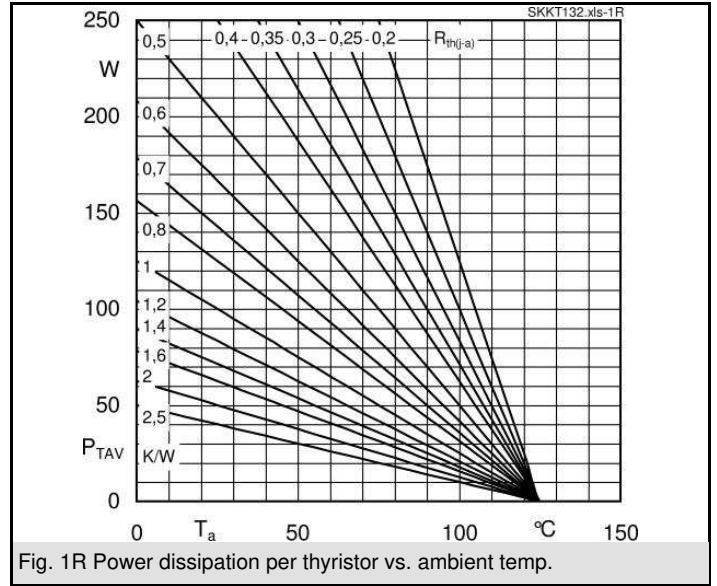
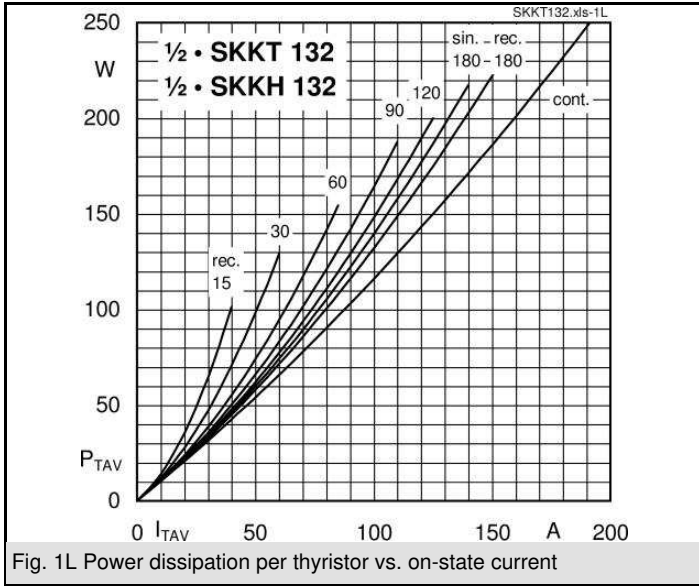

SKKT 132, SKKH 132

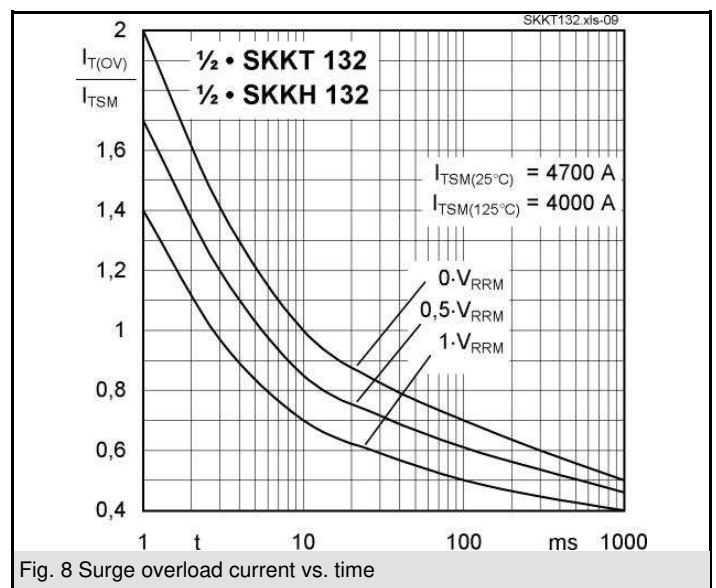
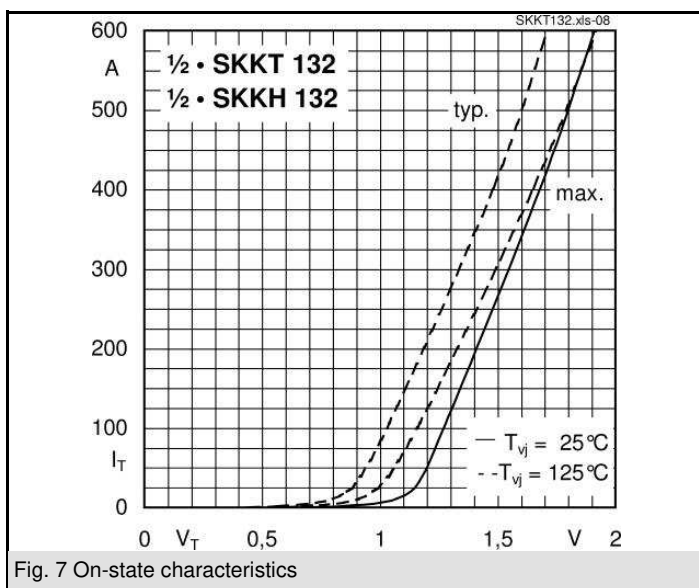
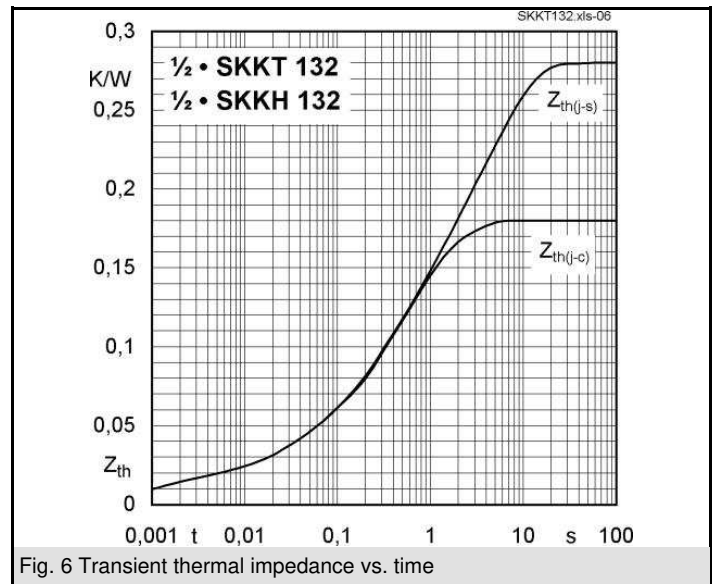
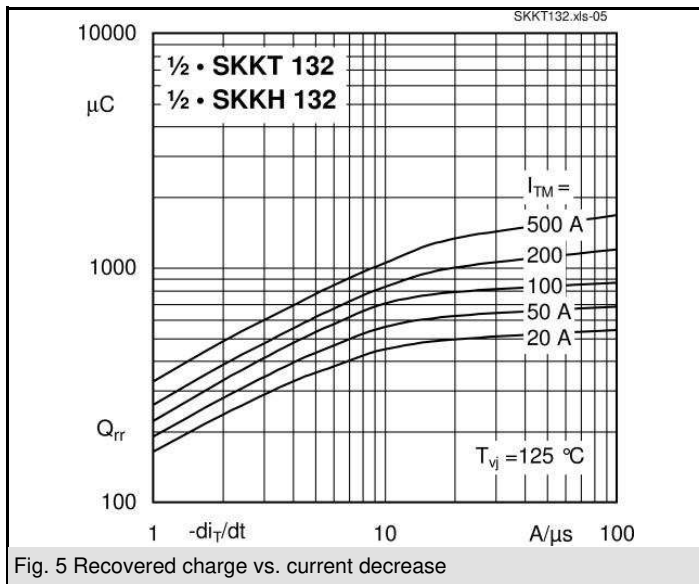
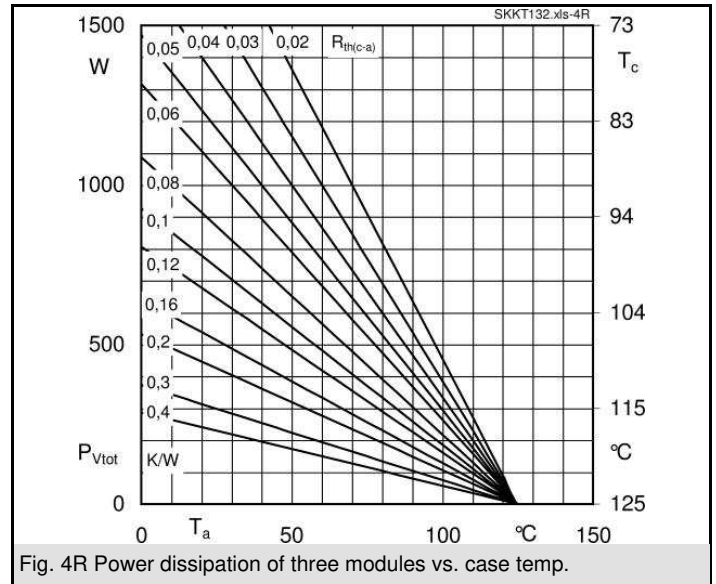
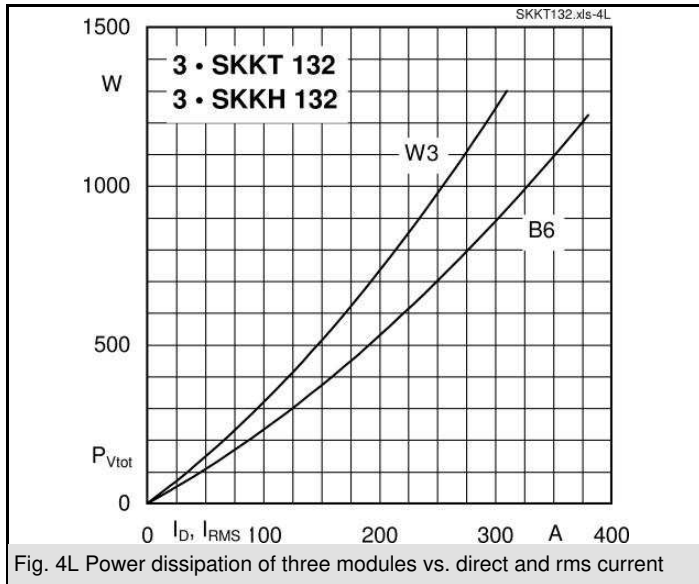

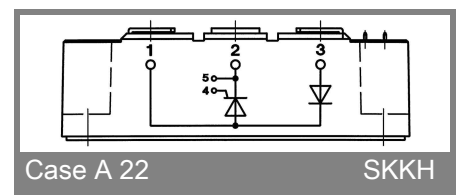
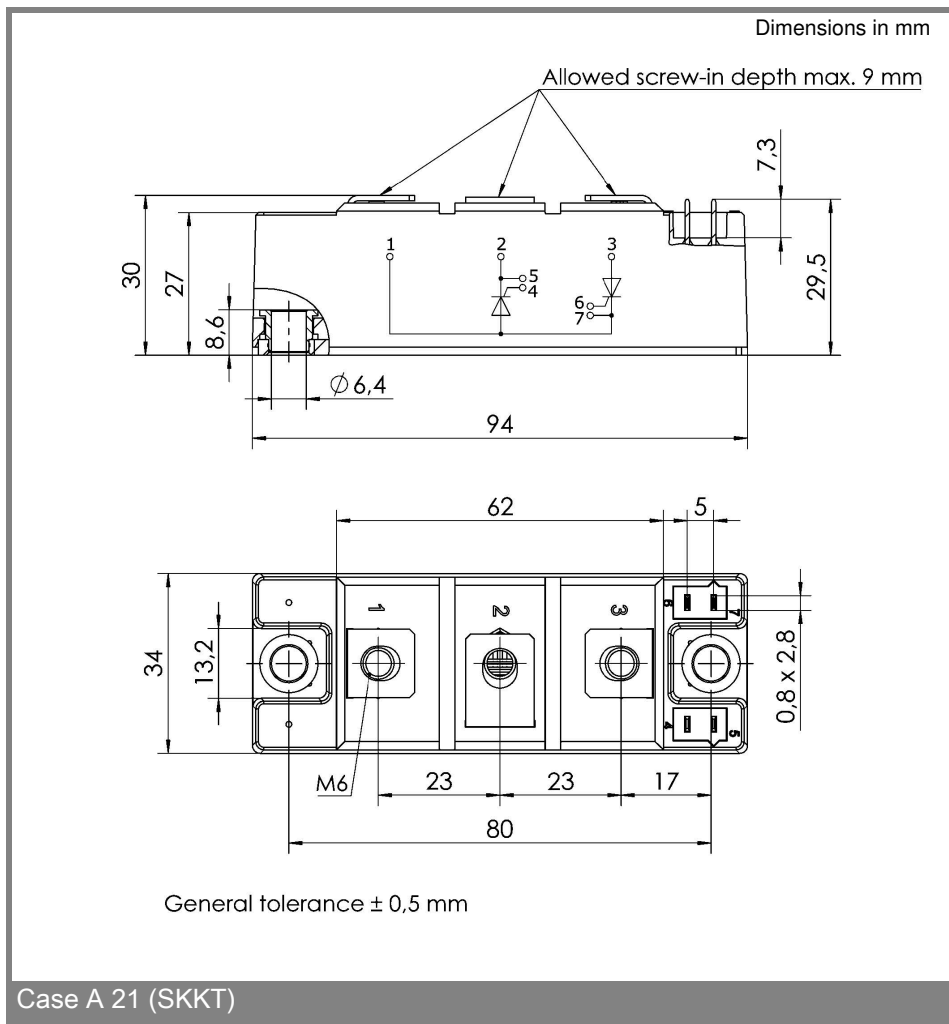
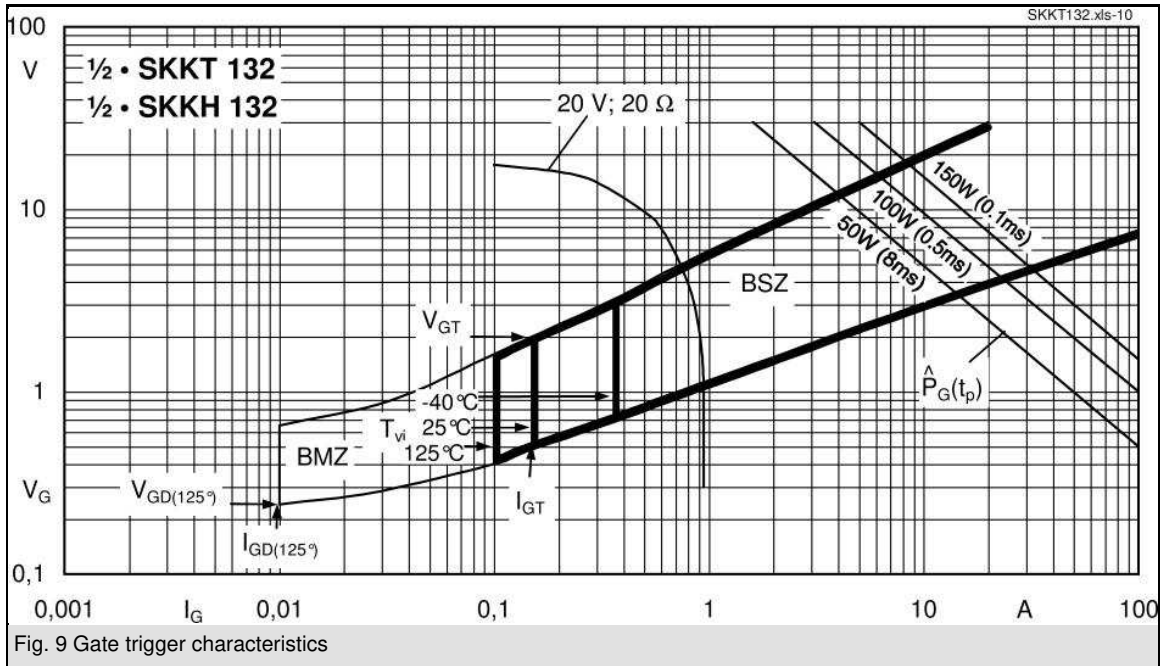

This is an electrostatic discharge sensitive device (ESDS) due to international standard IEC 61340.

***IMPORTANT INFORMATION AND WARNINGS**

The specifications of SEMIKRON products may not be considered as guarantee or assurance of product characteristics ("Beschaffenheitsgarantie"). The specifications of SEMIKRON products describe only the usual characteristics of products to be expected in typical applications, which may still vary depending on the specific application. Therefore, products must be tested for the respective application in advance. Application adjustments may be necessary. The user of SEMIKRON products is responsible for the safety of their applications embedding SEMIKRON products and must take adequate safety measures to prevent the applications from causing a physical injury, fire or other problem if any of SEMIKRON products become faulty. The user is responsible to make sure that the application design is compliant with all applicable laws, regulations, norms and standards. Except as otherwise explicitly approved by SEMIKRON in a written document signed by authorized representatives of SEMIKRON, SEMIKRON products may not be used in any applications where a failure of the product or any consequences of the use thereof can reasonably be expected to result in personal injury. No representation or warranty is given and no liability is assumed with respect to the accuracy, completeness and/or use of any information herein, including without limitation, warranties of non-infringement of intellectual property rights of any third party. SEMIKRON does not assume any liability arising out of the applications or use of any product; neither does it convey any license under its patent rights, copyrights, trade secrets or other intellectual property rights, nor the rights of others. SEMIKRON makes no representation or warranty of non-infringement or alleged non-infringement of intellectual property rights of any third party which may arise from applications. Due to technical requirements our products may contain dangerous substances. For information on the types in question please contact the nearest SEMIKRON sales office. This document supersedes and replaces all information previously supplied and may be superseded by updates. SEMIKRON reserves the right to make changes.