

# Thyristor Module

$$V_{RRM} = 2 \times 1600 \text{ V}$$

$$I_{TAV} = 110 \text{ A}$$

$$V_T = 1.21 \text{ V}$$

Phase leg

Part number

**MCMA110P1600VA**

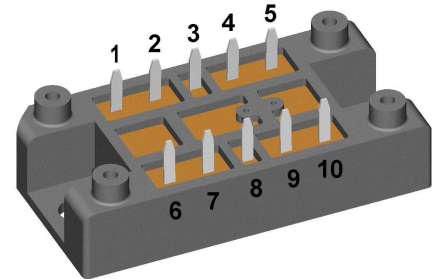

Backside: isolated

 E72873

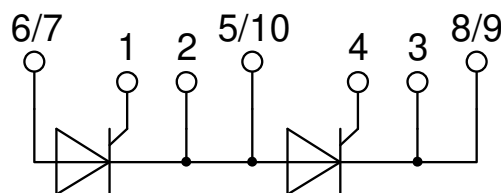

## Features / Advantages:

- Thyristor for line frequency
- Planar passivated chip
- Long-term stability
- Direct Copper Bonded Al<sub>2</sub>O<sub>3</sub>-ceramic

## Applications:

- Line rectifying 50/60 Hz
- Softstart AC motor control
- DC Motor control
- Power converter
- AC power control
- Lighting and temperature control

## Package: V1-A-Pack

- Isolation Voltage: 3600 V~
- Industry standard outline
- RoHS compliant
- Soldering pins for PCB mounting
- Height: 17 mm
- Base plate: DCB ceramic
- Reduced weight
- Advanced power cycling

## Disclaimer Notice

Information furnished is believed to be accurate and reliable. However, users should independently evaluate the suitability of and test each product selected for their own applications. Littelfuse products are not designed for, and may not be used in, all applications. Read complete Disclaimer Notice at [www.littelfuse.com/disclaimer-electronics](http://www.littelfuse.com/disclaimer-electronics).



Thyristor				Ratings			
Symbol	Definition	Conditions	min.	typ.	max.	Unit	
$V_{RSM/DSM}$	max. non-repetitive reverse/forward blocking voltage	$T_{VJ} = 25^{\circ}C$			1700	V	
$V_{RRM/DRM}$	max. repetitive reverse/forward blocking voltage	$T_{VJ} = 25^{\circ}C$			1600	V	
$I_{RD}$	reverse current, drain current	$V_{R/D} = 1600 V$	$T_{VJ} = 25^{\circ}C$		100	$\mu A$	
		$V_{R/D} = 1600 V$	$T_{VJ} = 140^{\circ}C$		10	mA	
$V_T$	forward voltage drop	$I_T = 110 A$	$T_{VJ} = 25^{\circ}C$		1.24	V	
		$I_T = 220 A$			1.52	V	
		$I_T = 110 A$	$T_{VJ} = 125^{\circ}C$		1.21	V	
		$I_T = 220 A$			1.57	V	
$I_{TAV}$	average forward current	$T_C = 85^{\circ}C$	$T_{VJ} = 140^{\circ}C$		110	A	
$I_{T(RMS)}$	RMS forward current	180° sine			170	A	
$V_{T0}$	threshold voltage	} for power loss calculation only	$T_{VJ} = 140^{\circ}C$		0.85	V	
$r_T$	slope resistance				3.3	m $\Omega$	
$R_{thJC}$	thermal resistance junction to case				0.3	K/W	
$R_{thCH}$	thermal resistance case to heatsink			0.2		K/W	
$P_{tot}$	total power dissipation		$T_C = 25^{\circ}C$		380	W	
$I_{TSM}$	max. forward surge current	$t = 10 \text{ ms}; (50 \text{ Hz}), \text{ sine}$	$T_{VJ} = 45^{\circ}C$		1.90	kA	
		$t = 8,3 \text{ ms}; (60 \text{ Hz}), \text{ sine}$	$V_R = 0 V$		2.05	kA	
		$t = 10 \text{ ms}; (50 \text{ Hz}), \text{ sine}$	$T_{VJ} = 140^{\circ}C$		1.62	kA	
		$t = 8,3 \text{ ms}; (60 \text{ Hz}), \text{ sine}$	$V_R = 0 V$		1.75	kA	
$I^2t$	value for fusing	$t = 10 \text{ ms}; (50 \text{ Hz}), \text{ sine}$	$T_{VJ} = 45^{\circ}C$		18.1	kA <sup>2</sup> s	
		$t = 8,3 \text{ ms}; (60 \text{ Hz}), \text{ sine}$	$V_R = 0 V$		17.5	kA <sup>2</sup> s	
		$t = 10 \text{ ms}; (50 \text{ Hz}), \text{ sine}$	$T_{VJ} = 140^{\circ}C$		13.0	kA <sup>2</sup> s	
		$t = 8,3 \text{ ms}; (60 \text{ Hz}), \text{ sine}$	$V_R = 0 V$		12.7	kA <sup>2</sup> s	
$C_J$	junction capacitance	$V_R = 400 V \quad f = 1 \text{ MHz}$	$T_{VJ} = 25^{\circ}C$		95	pF	
$P_{GM}$	max. gate power dissipation	$t_p = 30 \mu s$	$T_C = 140^{\circ}C$		10	W	
		$t_p = 300 \mu s$			5	W	
$P_{GAV}$	average gate power dissipation				0.5	W	
$(di/dt)_{cr}$	critical rate of rise of current	$T_{VJ} = 140^{\circ}C; f = 50 \text{ Hz}$	repetitive, $I_T = 330 A$		150	A/ $\mu s$	
		$t_p = 200 \mu s; di_G/dt = 0.45 A/\mu s;$ $I_G = 0.45 A; V = \frac{2}{3} V_{DRM}$	non-repet., $I_T = 110 A$		500	A/ $\mu s$	
$(dv/dt)_{cr}$	critical rate of rise of voltage	$V = \frac{2}{3} V_{DRM}$ $R_{GK} = \infty; \text{ method 1 (linear voltage rise)}$	$T_{VJ} = 140^{\circ}C$		1000	V/ $\mu s$	
$V_{GT}$	gate trigger voltage	$V_D = 6 V$	$T_{VJ} = 25^{\circ}C$		1.5	V	
			$T_{VJ} = -40^{\circ}C$		1.6	V	
$I_{GT}$	gate trigger current	$V_D = 6 V$	$T_{VJ} = 25^{\circ}C$		150	mA	
			$T_{VJ} = -40^{\circ}C$		200	mA	
$V_{GD}$	gate non-trigger voltage	$V_D = \frac{2}{3} V_{DRM}$	$T_{VJ} = 140^{\circ}C$		0.2	V	
$I_{GD}$	gate non-trigger current				10	mA	
$I_L$	latching current	$t_p = 10 \mu s$	$T_{VJ} = 25^{\circ}C$		200	mA	
		$I_G = 0.45 A; di_G/dt = 0.45 A/\mu s$					
$I_H$	holding current	$V_D = 6 V \quad R_{GK} = \infty$	$T_{VJ} = 25^{\circ}C$		200	mA	
$t_{gd}$	gate controlled delay time	$V_D = \frac{1}{2} V_{DRM}$	$T_{VJ} = 25^{\circ}C$		2	$\mu s$	
		$I_G = 0.45 A; di_G/dt = 0.45 A/\mu s$					
$t_q$	turn-off time	$V_R = 100 V; I_T = 110 A; V = \frac{2}{3} V_{DRM}$ $di/dt = 10 A/\mu s \quad dv/dt = 20 V/\mu s \quad t_p = 200 \mu s$	$T_{VJ} = 125^{\circ}C$		185	$\mu s$	



Package V1-A-Pack		Ratings				
Symbol	Definition	Conditions	min.	typ.	max.	Unit
$I_{RMS}$	RMS current	per terminal			100	A
$T_{VJ}$	virtual junction temperature		-40		140	°C
$T_{op}$	operation temperature		-40		125	°C
$T_{stg}$	storage temperature		-40		125	°C
<b>Weight</b>				37		g
$M_D$	mounting torque		2		2.5	Nm
$d_{Spp/App}$	creepage distance on surface / striking distance through air	terminal to terminal	6.0			mm
$d_{Spb/Apb}$		terminal to backside	12.0			mm
$V_{ISOL}$	isolation voltage	t = 1 second	3600			V
		t = 1 minute	3000			V



**Part description**

- M = Module
- C = Thyristor (SCR)
- M = Thyristor
- A = (up to 1800V)
- 110 = Current Rating [A]
- P = Phase leg
- 1600 = Reverse Voltage [V]
- VA = V1-A-Pack

Ordering	Ordering Number	Marking on Product	Delivery Mode	Quantity	Code No.
Standard	MCMA110P1600VA	MCMA110P1600VA	Blister	24	517908

**Equivalent Circuits for Simulation**

\* on die level

$T_{VJ} = 140^{\circ}C$



**Thyristor**

$V_{0\ max}$	threshold voltage	0.85	V
$R_{0\ max}$	slope resistance *	2.1	mΩ



**Outlines V1-A-Pack**

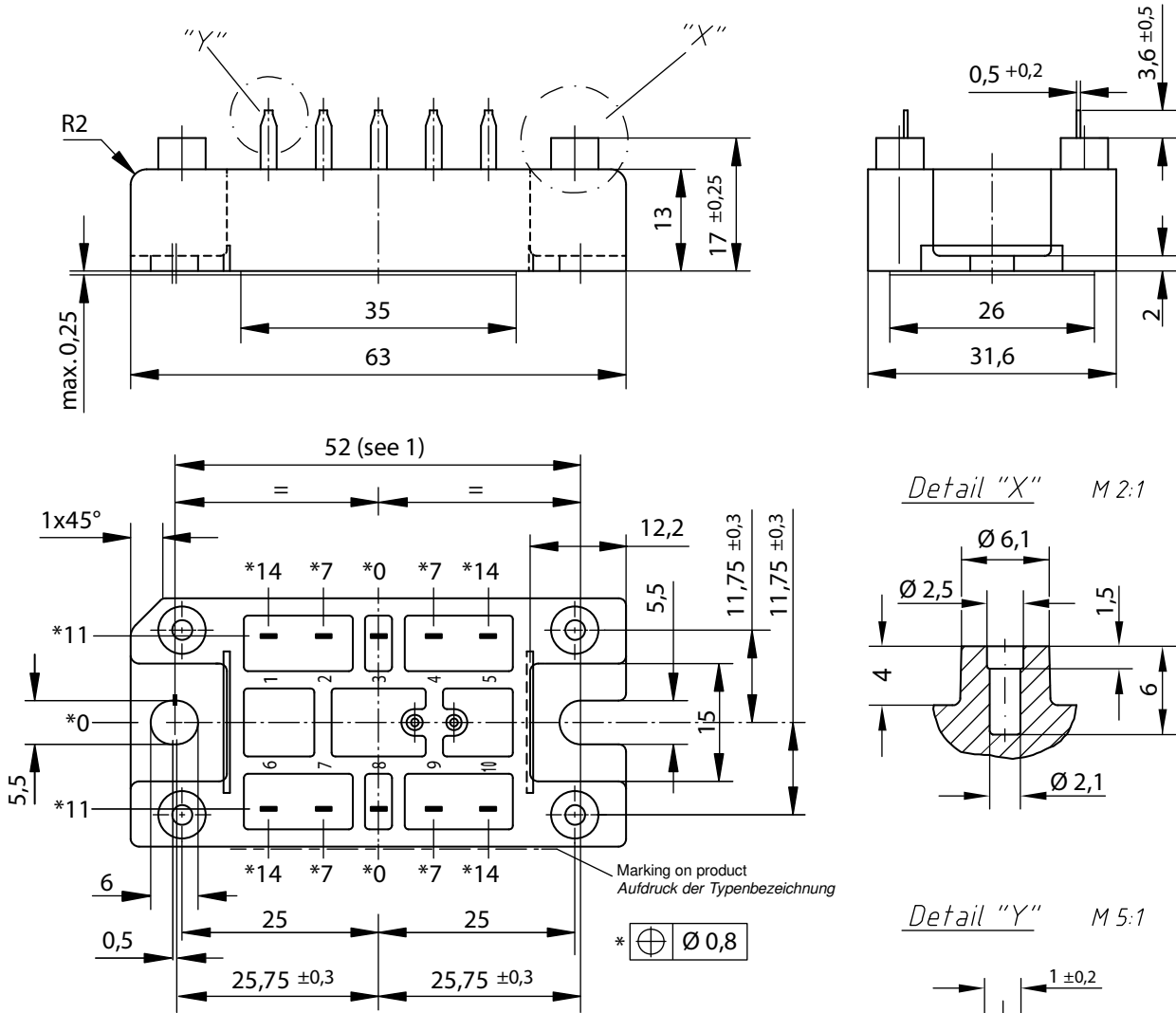

**Remarks / Bemerkungen:**

1. Nominal distance mounting screws on heat sink: 52 mm / Nennabstand Befestigungsschrauben auf Kühlkörper: 52 mm
  2. General tolerance / Allgemeintoleranz: DIN ISO 2768 -T1-c
  3. Surface treatment of pins: tin plated (Sn) in hot dip / Oberflächenbehandlung der Pins: verzinkt (Sn) im Tauchbad
  4. Detail X: EJOT PT® self-tapping screws (dimension K25) to be recommended for mounting on PCB  
selbstschneidende Schraube (Größe K25) empfohlen für die PCB-Montage
- Take care on the maximum screw length according to board thickness and the maximum hole depth of 6 mm<sup>L</sup>  
Bei der Wahl der Schraubenlänge die PCB-Dicke und die maximale Lochtiefe von 6mm beachten
- Recommended mounting torque: 1.5 Nm / Empfohlenes Drehmoment: 1.5 Nm

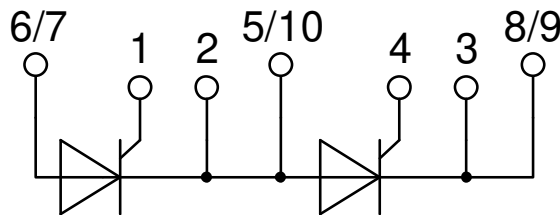

**Thyristor**

Fig. 1 Forward characteristics

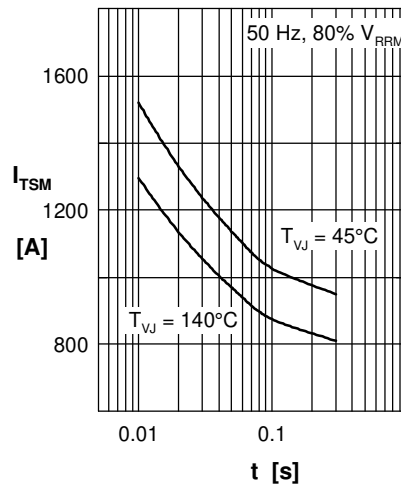
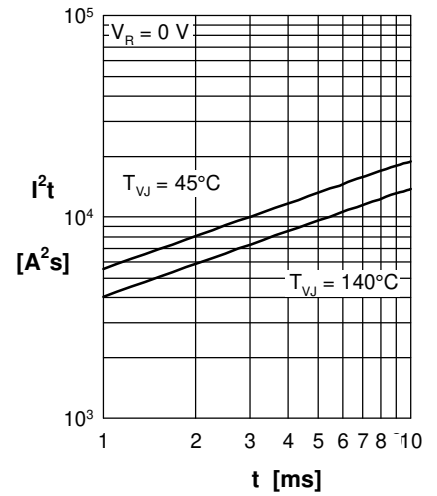
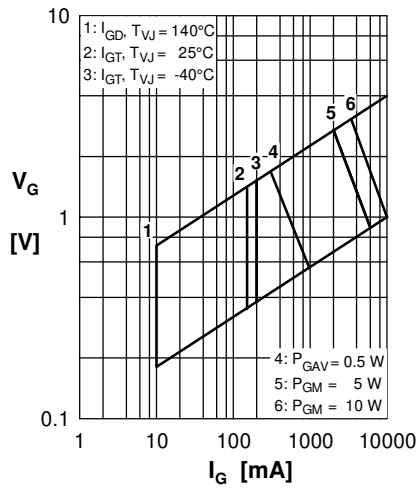

 Fig. 2 Surge overload current  
 $I_{TSM}$ : crest value,  $t$ : duration

 Fig. 3  $I^2t$  versus time (1-10 s)

Fig. 4 Gate voltage &amp; gate current

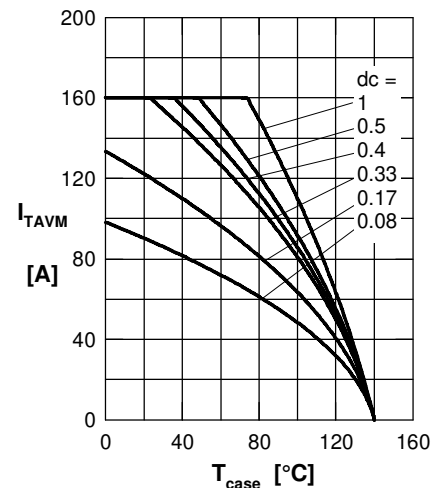

 Fig. 5 Gate controlled delay time  $t_{gd}$ 

Fig. 6 Max. forward current at case temperature

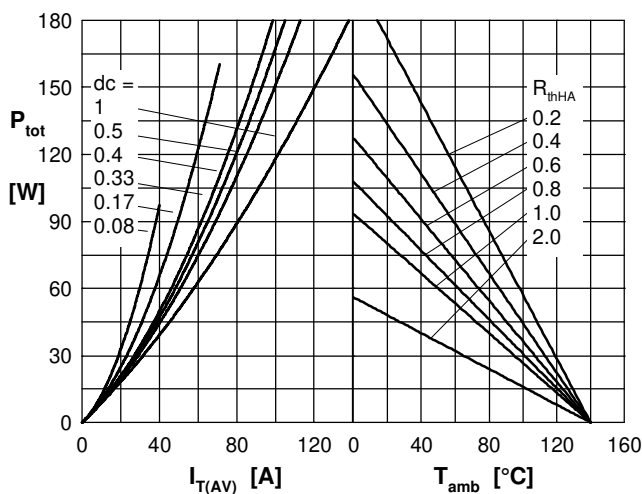

 Fig. 7a Power dissipation versus direct output current  
 Fig. 7b and ambient temperature

Fig. 8 Transient thermal impedance junction to case